



ISO 9001
Certificate



ISO 14001
Certificate



SIGMA

Your Elevator Partner
www.sigmaelevator.com

MUSE™ NV

Machine Roomless Elevator



Your Elevator Partner... SIGMA

SIGMA Ride tomorrow, Lift future



Korean Engineered Products

SIGMA products are engineered by highly qualified Korean engineers and ensure customers to receive excellent products with reliable quality.



Aesthetics Design Excellence

SIGMA's Design Center in Korea and China are fully equipped with professionals who follow the most up-to-date aesthetic designs to satisfy customers needs.



Global Network

SIGMA has been with you for more than 45 years serving over 60 Countries.



SIGMA has already exported approximately 100,000 elevators worldwide since year 1978

● SIGMA SUBS ● DISTRIBUTORS

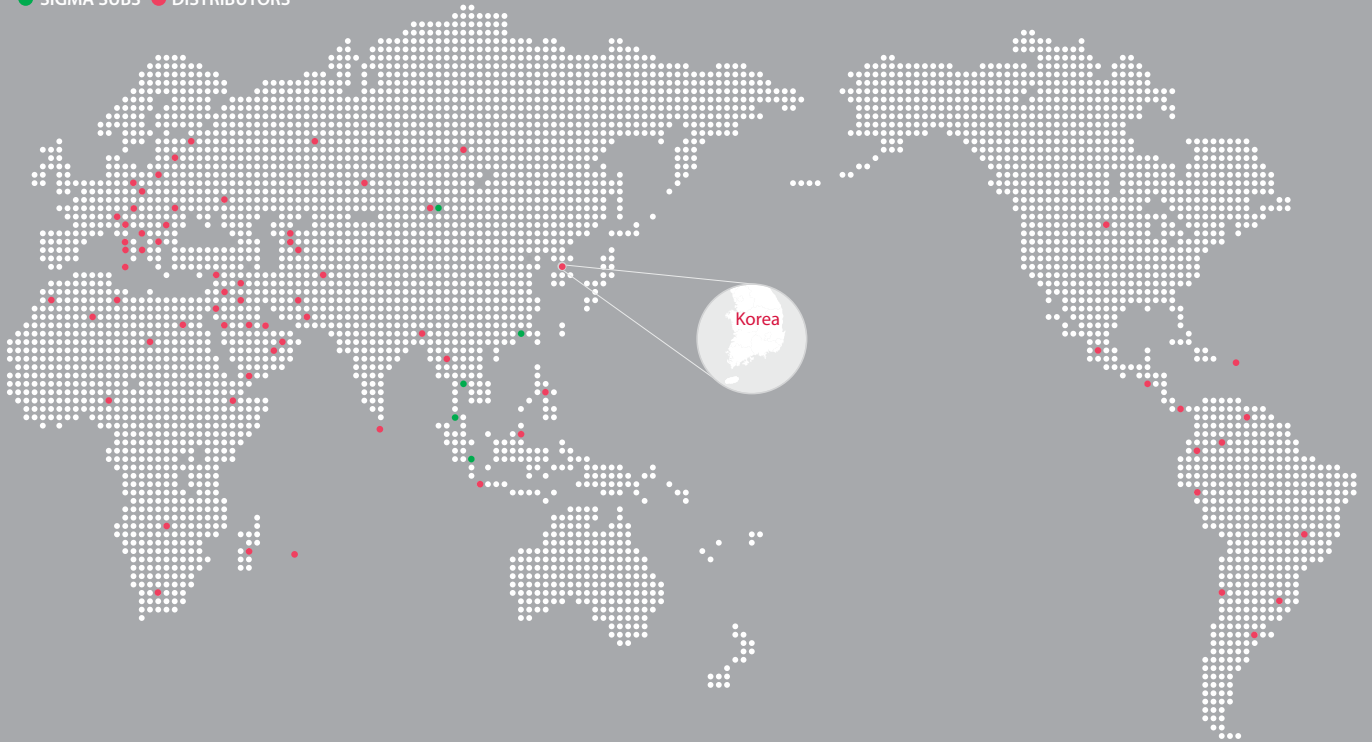

Khalid Al Attar Tower
UAE



Al Rames Tower
Qatar



Darwaza Tower
Kuwait



Vorobiev Gory
Russia



Triumph Palace
Russia



Antey
Russia



Sheraton Hotel
Puerto Rico



Baiyoke Tower
Thailand



Grand Hyatt Hotel
Indonesia



Emerald Tower
Kazakhstan



LG Beijing Tower
China



ASEM Tower
Korea



Intercontinental Hotel
Korea



Korea World Trade Center
Korea



Plaza La Castellana
Venezuela



Torre Global Bank
Panama



Ocean Two
Panama

Next Generation Elevator

PM Gearless, coated steel reinforced belt and green technology
that re-invents an industry



MUSE™ NV



1 Flexible Steel Belts

The polyurethane-coated flat steel belt is up to 40% lighter and lasts up to 3 times longer than conventional ropes. Its flexibility results in a much smaller bending radius.

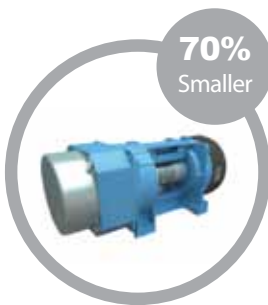

2 Compact Gearless Machine

A sheave has allowed SIGMA to design a machine that is up to 70% smaller than conventional ones.

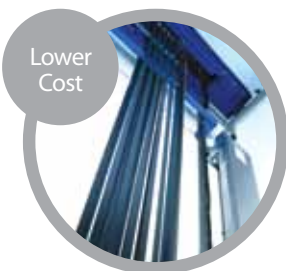

Machine Roomless System

The compact MUSE NV gearless machine does not require a machine room and can be easily positioned on the guide rails. This means all bearing loads can be transferred to the pit, thus reducing structural building costs.

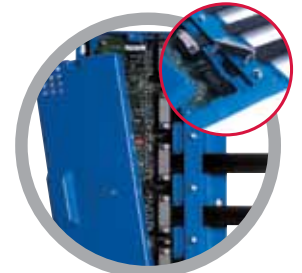
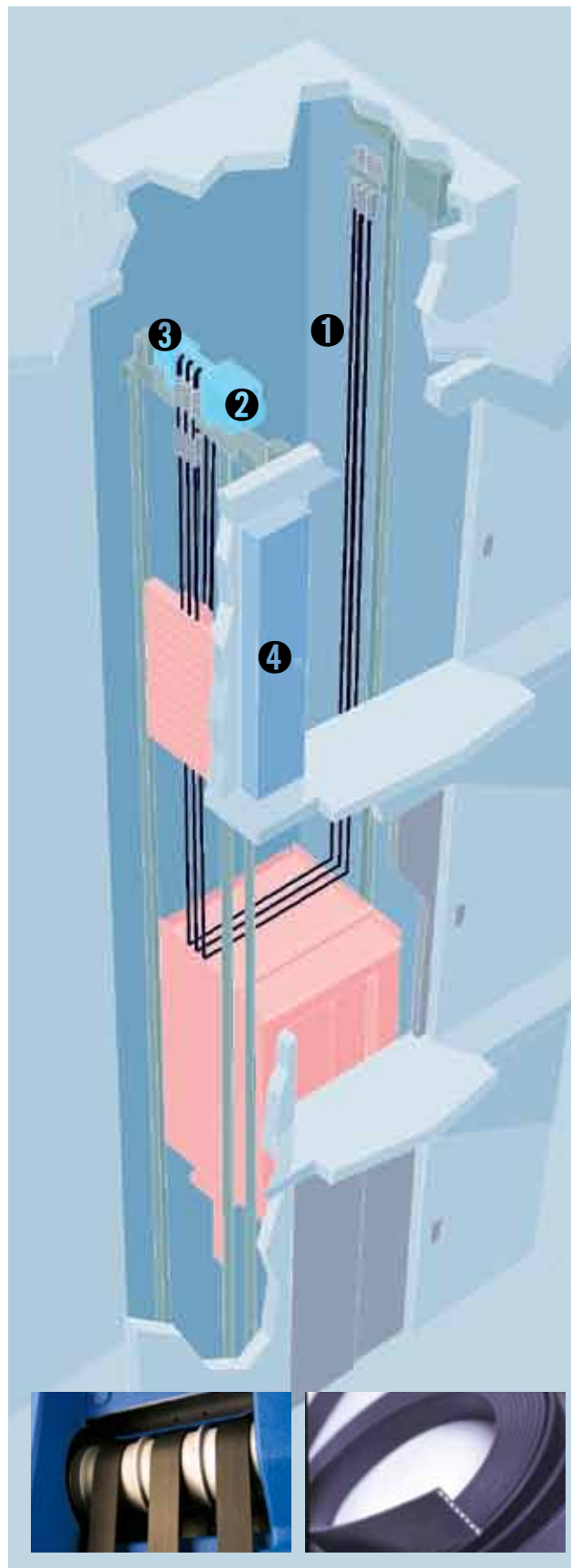

3 PULSE System

The PULSE electronic system continually monitors the status of the belts' steel cords. In contrast to visual inspections of conventional steel ropes, the PULSE system automatically detects and informs technicians of the quality of the belt cord, thus eliminating downtime and greatly enhancing the reliability of the inspection.

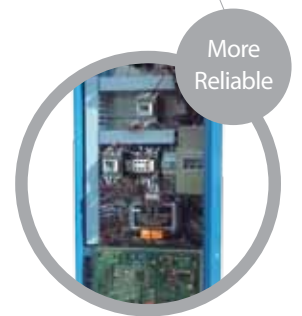

4 Reliable Controller

Designed for groups of up to four cars, the modular controller incorporates a new generation of printed circuits and software to provide optimal response time. The digital closed-loop variable frequency (VF) drive, with vector control technology, further increases efficiency and accuracy, and a digital speed encoder ensures correct car speed and positioning. The result is a system of exceptional reliability.

Coated Steel Reinforced Belt

The passengers' safety is of the utmost importance, so SIGMA maintains the highest standards in safety technology. The flat belt technology used in the MUSE NV represents a superior innovation in safety.

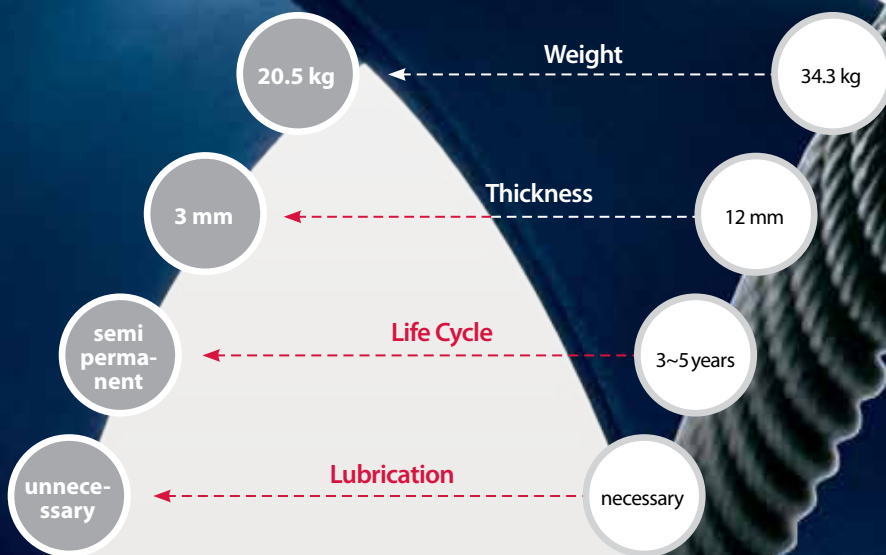
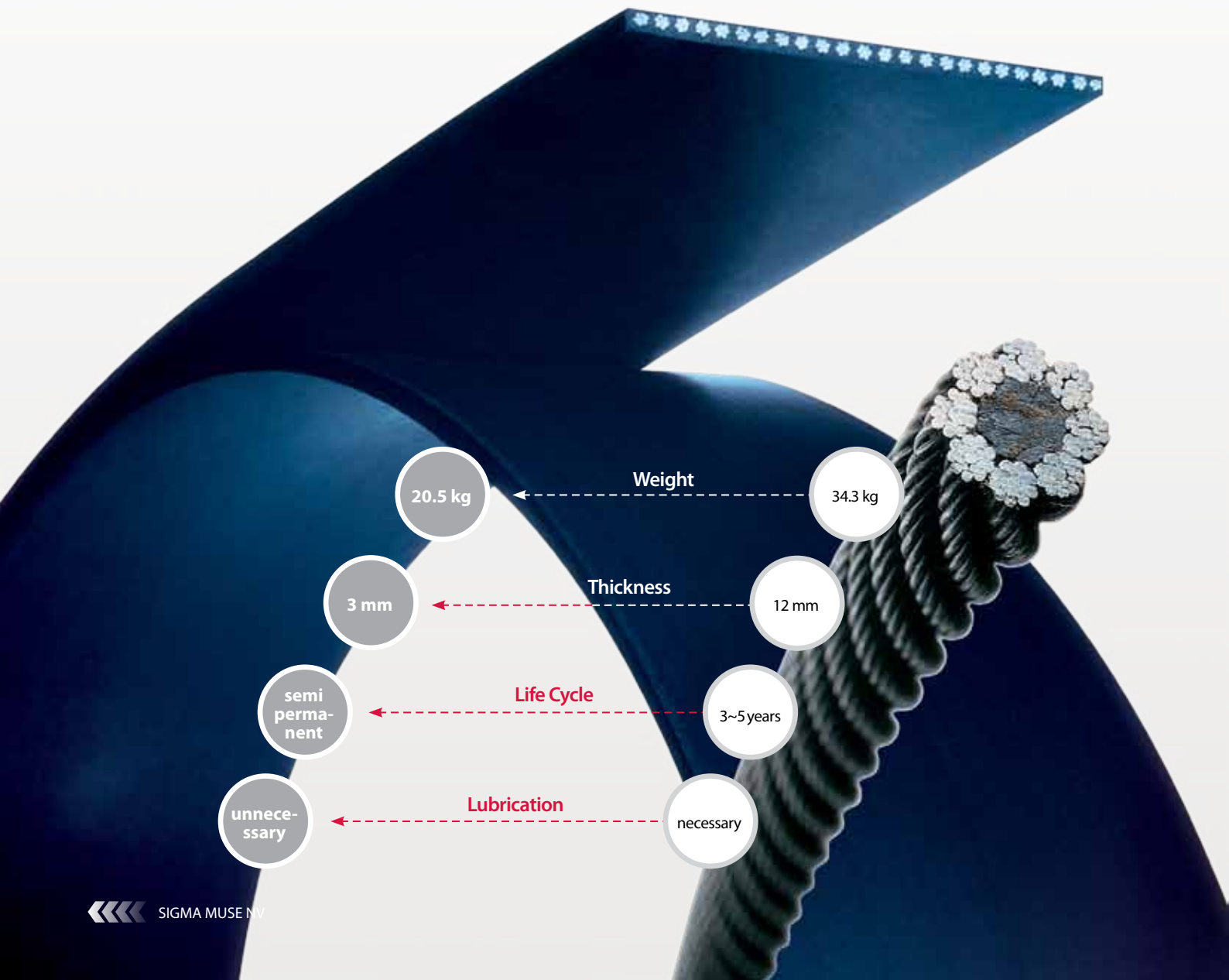

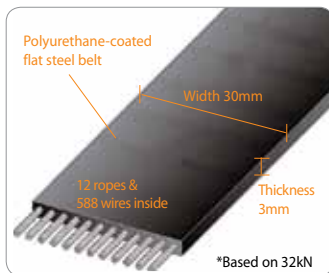

Excellent Traction Power

One flat belt can lift up elevator weighing up to 3,600kg with its excellent traction power.

Semi-permanent Life Cycle

The life cycle of polyurethane coated belts with a thickness of 3mm, a width of 30mm, and 588 wires is three times longer than the ropes used in existing systems which require periodic replacement every 3 - 5 years.

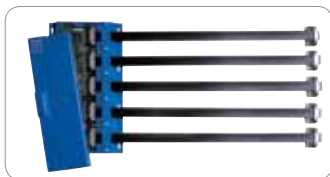

PULSE System

The PULSE System electrically checks the abrasion status and operating conditions in real-time to make maintenance more efficient and easier.



40% Lighter Belt

Weighing 40% less than the steel ropes used in other elevators, the flat belt significantly reduces energy consumption.

MUSE NV's flat belt system ensures your safety.

Leading to a Green Future

MUSE NV makes our world better.

MUSE NV realizes sustainable growth, with low cost and high energy efficiency, by applying an environmentally friendly and energy efficient system. And, MUSE NV also provides a comfortable ride that no other system can offer.



Lubrication-Free

Neither the belts nor the gearless machine with sealed-for-life bearings require any form of polluting lubricants. The need for oil in the machine is eliminated by the absence of a gear box. Unlike steel cables, the belts require no lubrication.



Soft and Quiet Ride

VVVF digital closed-loop drive minimizes internal vibration and the flat belts eliminate the metallic rubbing noise that comes from the steel ropes and sheaves found in other elevators.



30% Energy Saving System

The low-inertia gearless machine with a permanent magnet (PM) synchronous motor means energy savings and reduced operating costs.

MUSE NV reduces the energy consumption **up to 30%**

Category	Conventional Elevator	MUSE NV
Machine	Geared Machine	PM (Permanent Magnet) Gearless Machine
Energy Efficiency	Geared (80%)	Gearless (90%)
Power Consumption (For 17-Passengers)	47.7 kwh	34.3 kwh



MUSE NV is an eco-friendly
next generation elevator

MUSE NV Standard Design & Fixtures

Modern | Elevator Design |

Simple stripe pattern of Modern is the basic design, preferred by many people

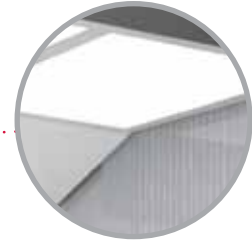

| C-RS1 |

One side of ceiling is lifted, so the space is increased.



| Front View |

| Rear View |

Specification

CEILING	C-RS1
COP	CBX-22C
CAR DOOR FINISH	EH3-084
HANDRAIL	HR04-38HL
FLOOR	Decotile

! The actual product can be different (changed) depending on design
Car wall image can be different (changed) depending on capacity

MUSE NV Standard Design & Fixtures

Mondrian | Elevator Design

Mondrian shows the beautiful appearance with its colorful light and quiet pattern of wall



| Front View |

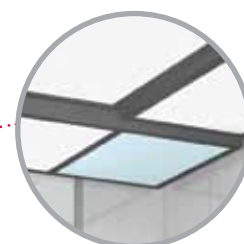

| C-RS2 |

The acryl ceiling in Mondrian look brightens the space and provides the artistic atmosphere.



| Rear View |

Specification

CEILING	C-RS2
COP	CBX-22C
CAR WALL FINISH	EH3-034
HANDRAIL	HR04-38HL
FLOOR	Decotile

The actual product can be different (changed) depending on design
Car wall image can be different (changed) depending on capacity

MUSE NV Standard Design & Fixtures

Tangent | Elevator Design |

The tangent design with stainless mirror and floral pattern ignites the sense of modern design

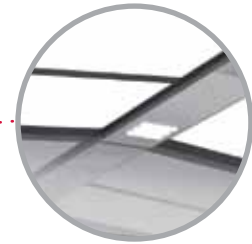

| C-NL2 |

The center of the ceiling is mounted, and the car space looks wider



| Front View |

| Rear View |

Specification

CEILING	C-NL2
COP	CBX-22C
CAR WALL FINISH	EH1-086
HANDRAIL	HR04-38POL
FLOOR	Decotile

! The actual product can be different (changed) depending on design
Car wall image can be different (changed) depending on capacity

Car & Landing Fixtures |

| COP

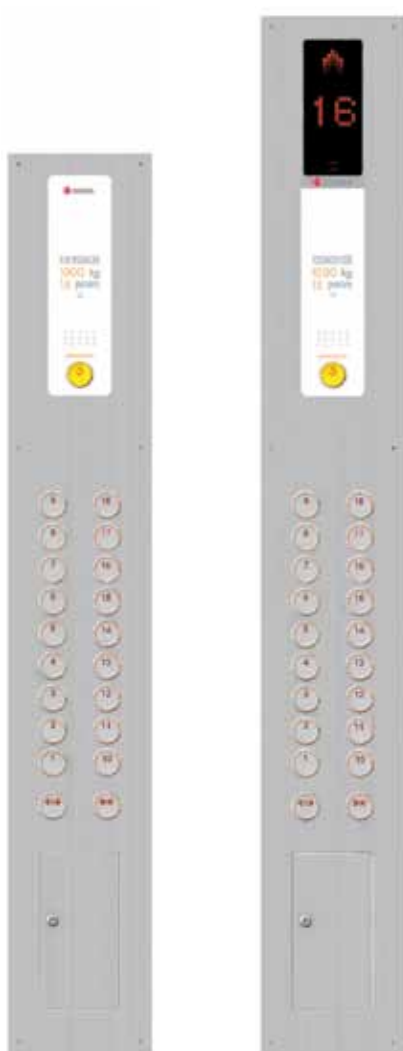

CBM-22

CBX-22C

| Vertical Hall Indicator



VIX-M652

VIX-MA52S

| Hall Button



HBM-R45

HBM-RA5S

HBM-R65

| Handicapped COP



CBM-44SH

The actual product can be different (changed) depending on design

Car & Landing Fixtures II (Option)

I COP Premium Design (Option)

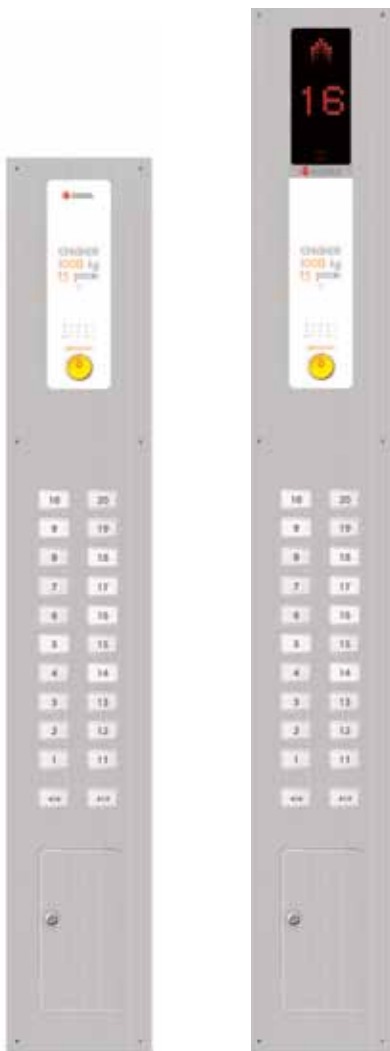

CBM-16

CBX-16C

I Vertical Hall Indicator Premium Design (Option)



VIX-M692

VIX-MA92S

I Hall Button



HBM-S49

HBM-SA9S

! The actual product can be different (changed) depending on design

Car & Landing Fixtures III (Option)

I COP



CBL-85C

I Horizontal Hall Indicator



HIL-C193



HIL-A193

I Vertical Hall Indicator



VIL-MBB2S

I Hall Button



HBM-RBBS

I Handicapped COP



CBM-D1SH

The actual product can be different (changed) depending on design

Car Position Indicator



CIX-10



CIX-13

Horizontal Hall Indicator



HIX-A162



HIX-C162

Hall Lantern



HLV-C08



HLV-C11



HLV-C48

! The actual product can be different (changed) depending on design

Ceiling Designs



C-RS1 (LGP-945)



C-RS2 (LGP-945)



C-NS1



C-NS3



C-RL1 [Option]



C-NL2 (LGP-945) [Option]



(Including Air Purifier)



C-RL2 [Option]

Colors

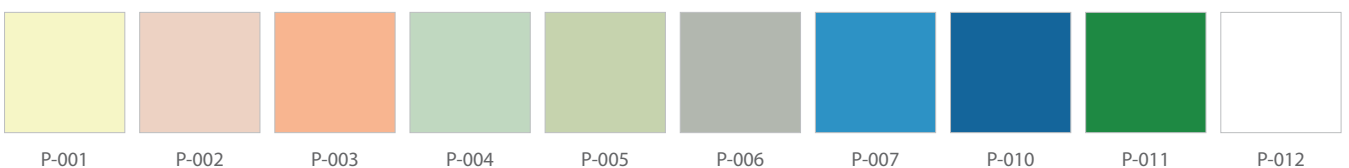

The actual product can be different (changed) depending on design

Etching Pattern

I STS Etching Pattern



EH3-034

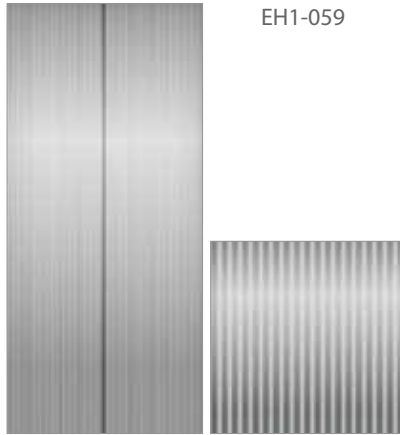

EH1-059

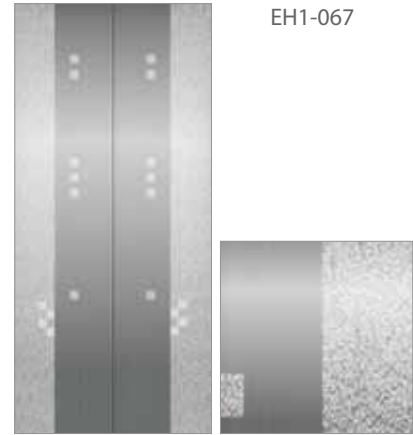

EH1-067

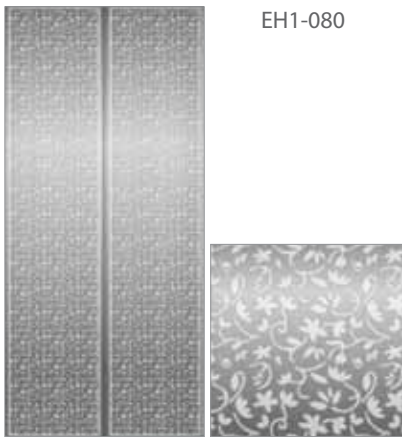

EH1-080

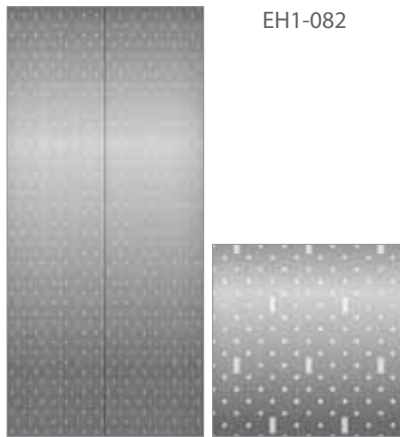

EH1-082

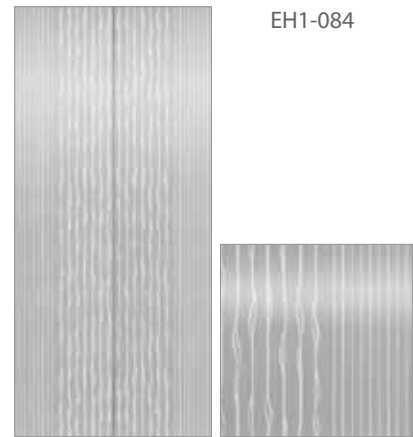

EH1-084



EH1-085

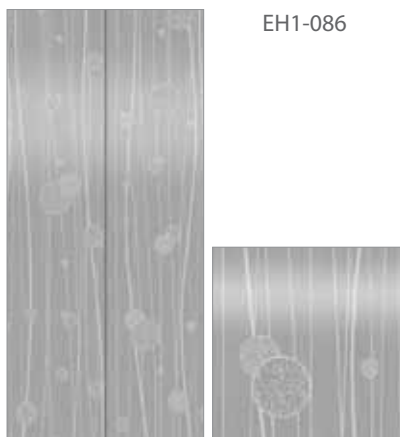

EH1-086



EH1-087

! The actual product can be different (changed) depending on design

Entrance Design

| Ground Floor



JAMB	J-311 (STS Mirror)
DOOR	STS Mirror Etching (EH1-085)
HALL IND	HIX-A162
HALL LANTERN	HLV-C08
HALL BUTTON	HBM-R45

| Top Floor



JAMB	J-301 (STS Hairline)
DOOR	STS Hairline Etching (EH1-085)
HALL IND & BUTTON	VIX-M652
LANDING CABINET	STS Hairline

| Typical Floors



JAMB	J-301 (STS Hairline)
DOOR	STS Hairline Etching (EH3-034)
HALL IND & BUTTON	VIX-M652

| Typical Floors



JAMB	J-101 (STS Hairline)
DOOR	Stainless Steel Hairline
HALL IND & BUTTON	VIX-M652

The actual product can be different (changed) depending on design

Technical Data Overhead

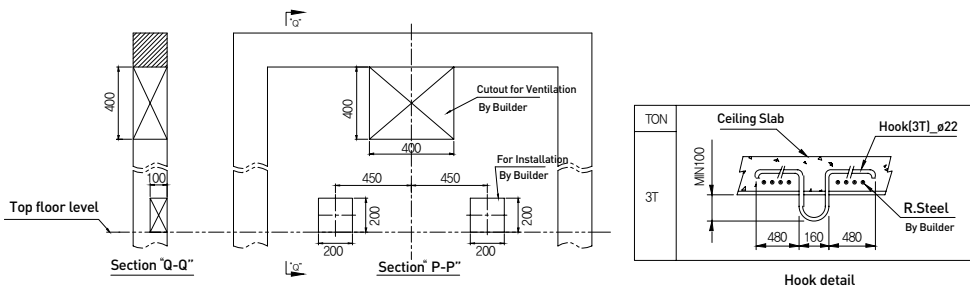

DUTY (kg)	SPEED (m/s)	K-CH (mm)	TYPE
≤1275	1	<1533	TYPE 2
	1	≥1533	TYPE 1
	1.5	<1680	TYPE 2
	1.5	≥1680	TYPE 1
	1.75	<1743	TYPE 2
≥1350	1.75	≥1743	TYPE 1
	1	ALL	TYPE 3
	1.5	<1942	TYPE 4
	1.5	≥1942	TYPE 3
	1.75	<2005	TYPE 4
1.75	≥2005	TYPE 3	

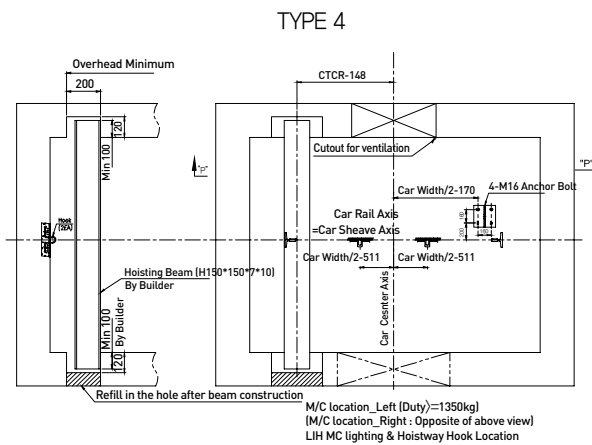
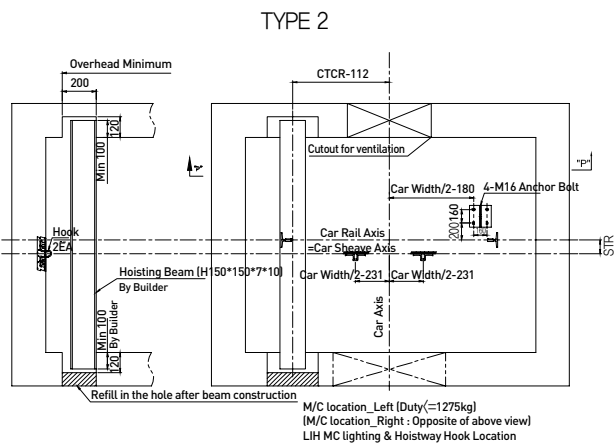
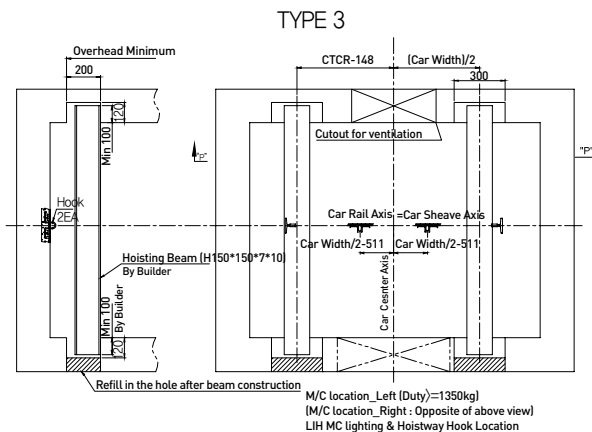
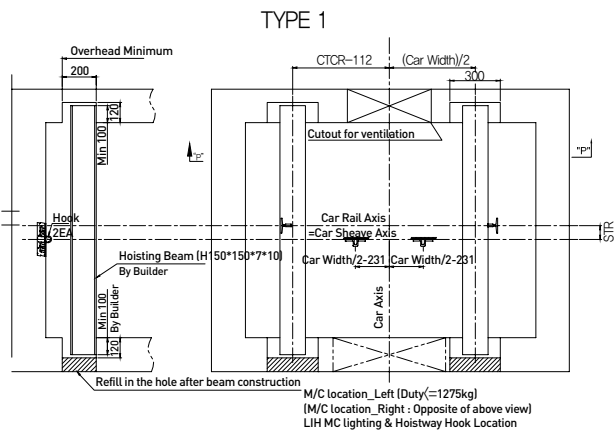

Contact our company for overhead reaction force and the dimensions of detailed hoist-way patch

Technical Data Hoistway

Hoistway Section

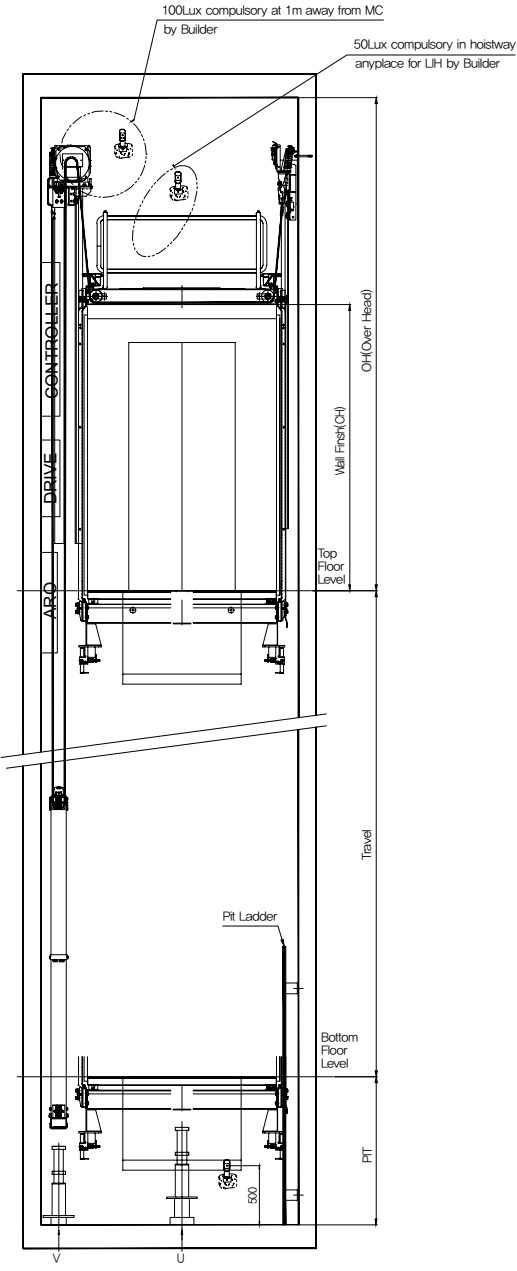

Hoistway Plan

(Passenger / Simplex)

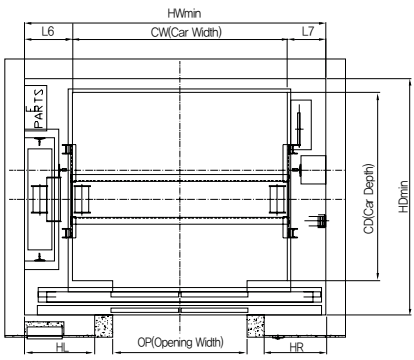

(Passenger / Duplex)

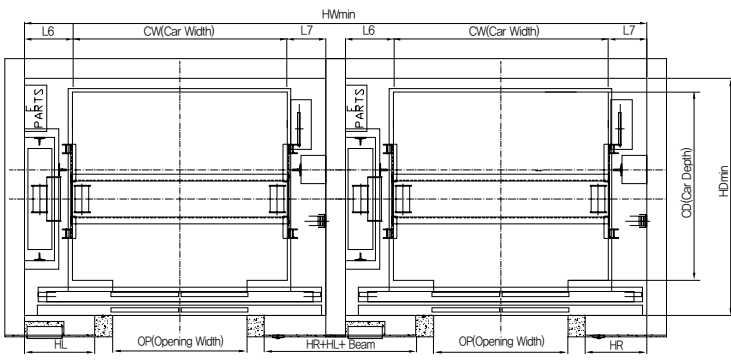

Technical Data Entrance

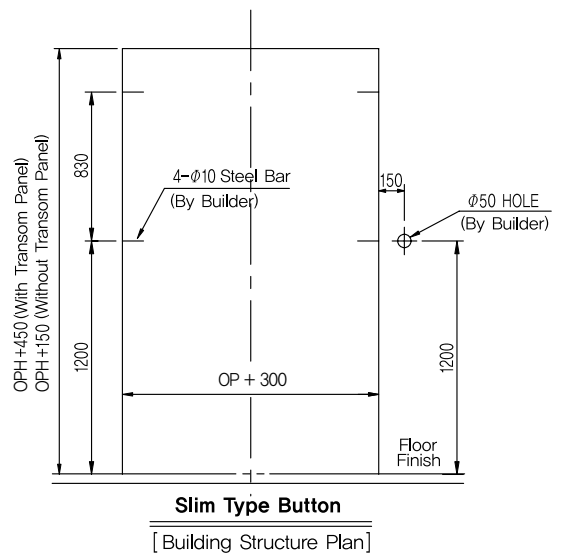
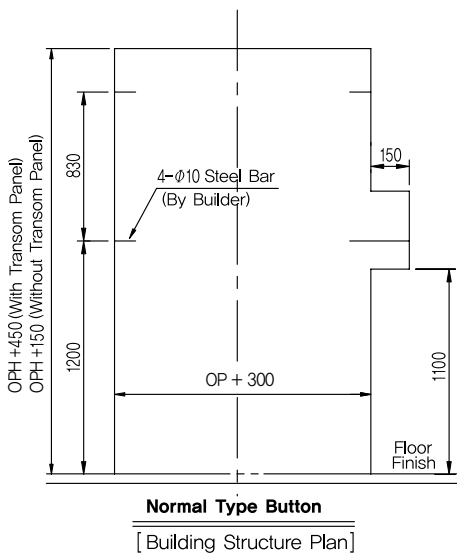
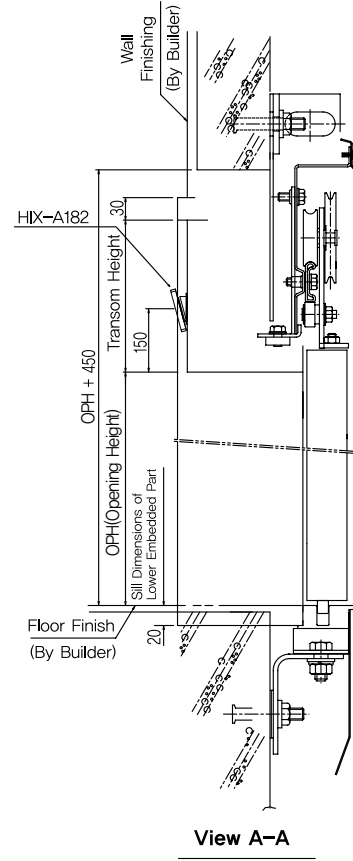
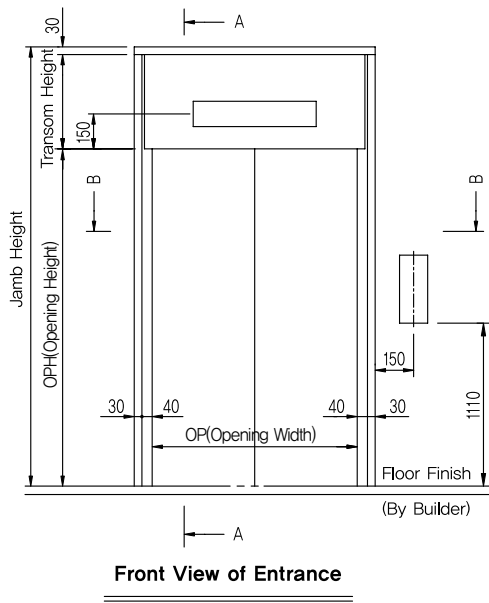
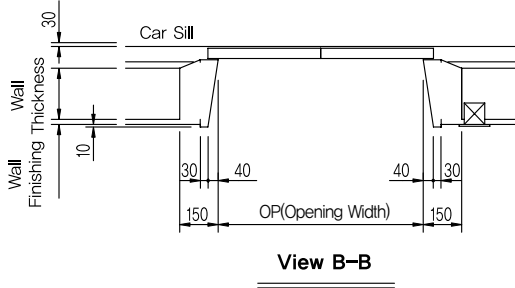

Technical Data Entrance

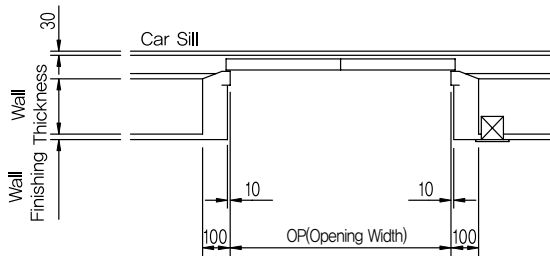

View B-B

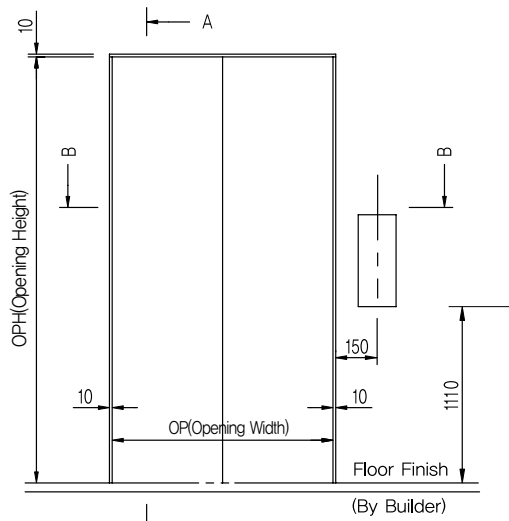

Front View of Entrance

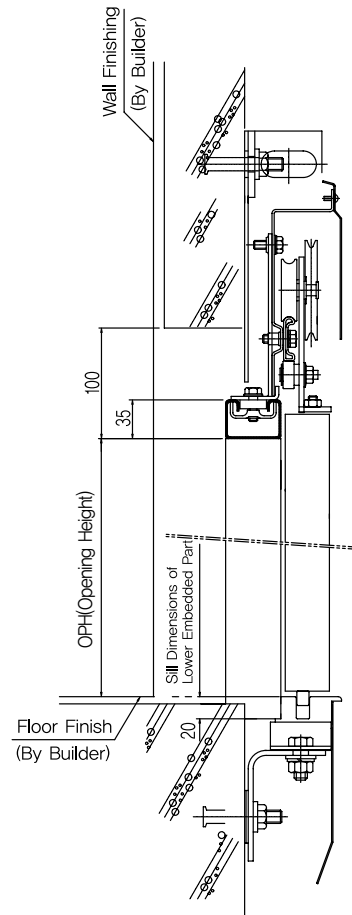

View A-A

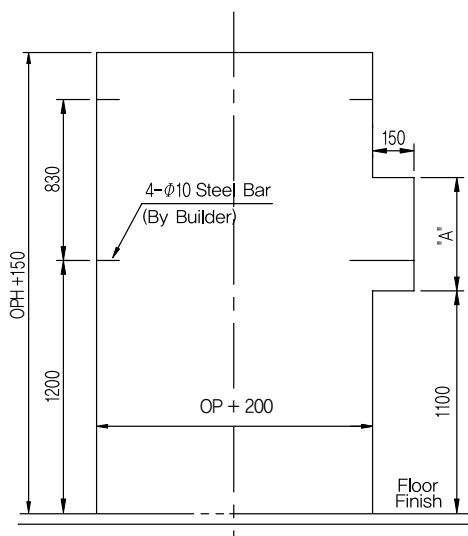

Normal Type Button

[Building Structure Plan]

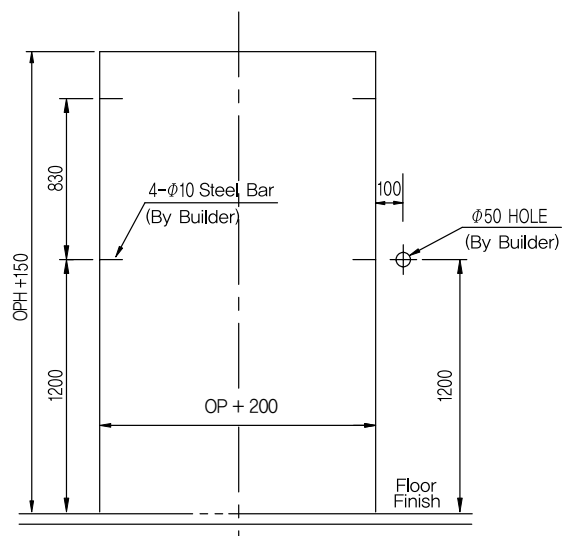

Slim Type Button

[Building Structure Plan]

Technical Data Entrance (Top Floor)

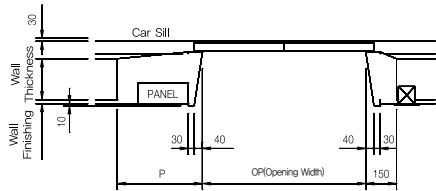

Wide Taper Type
[View B-B]

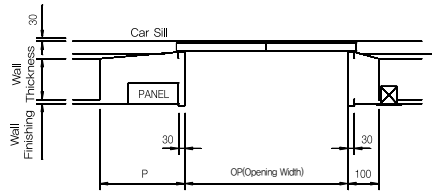

Wide Straight Type
[View B-B]

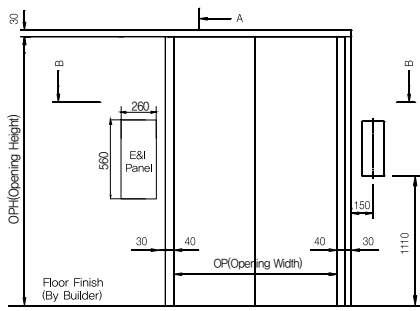

Front View of Entrance

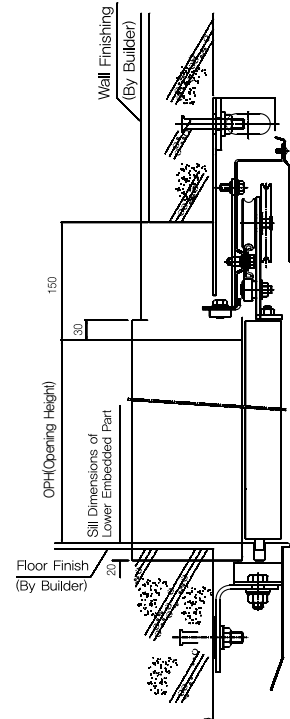
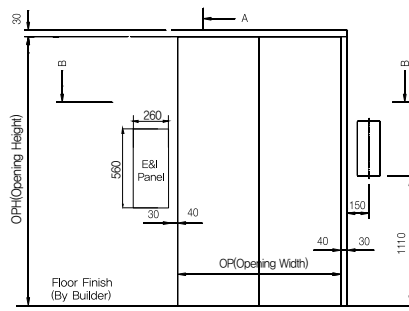

Section A-A

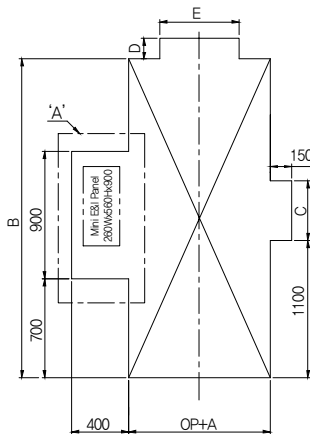

Normal Type Button
[Building Structure Plan]

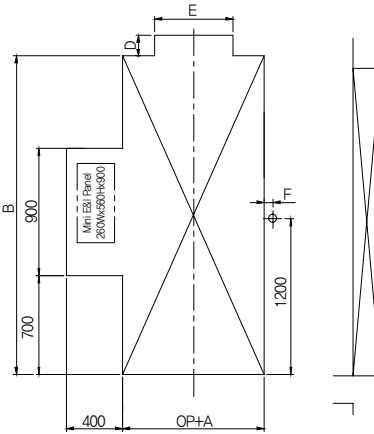

Slim Type Button
[Building Structure Plan]

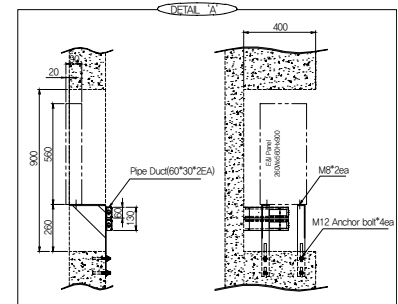

Technical Data Steel Frame Entrance

Wide Taper Jamb (Except Top Floor)

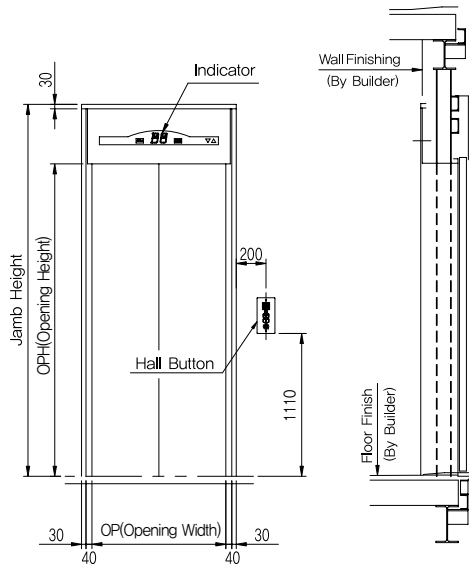

Front View of Entrance

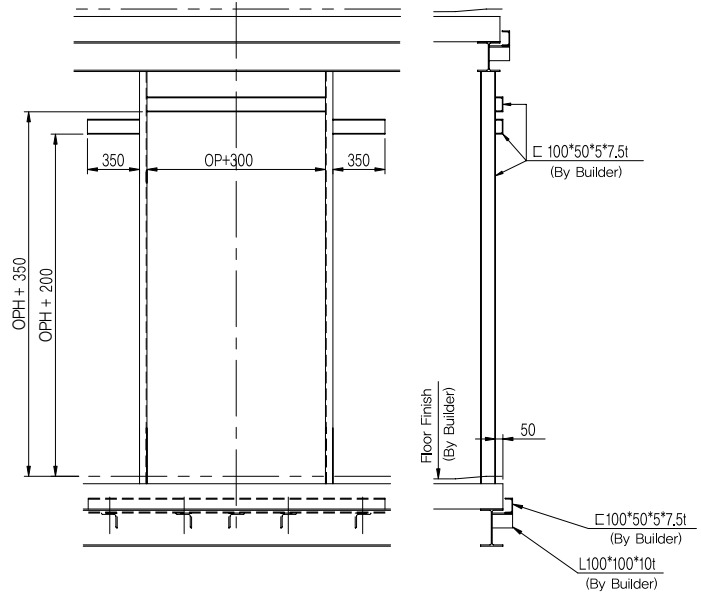

Steel Frame Diagram of Entrance

Narrow Jamb

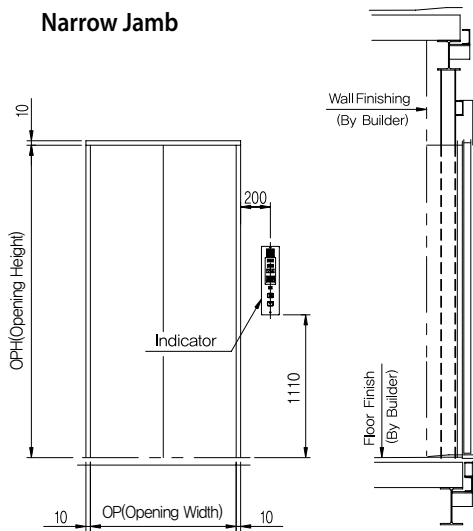

Front View of Entrance

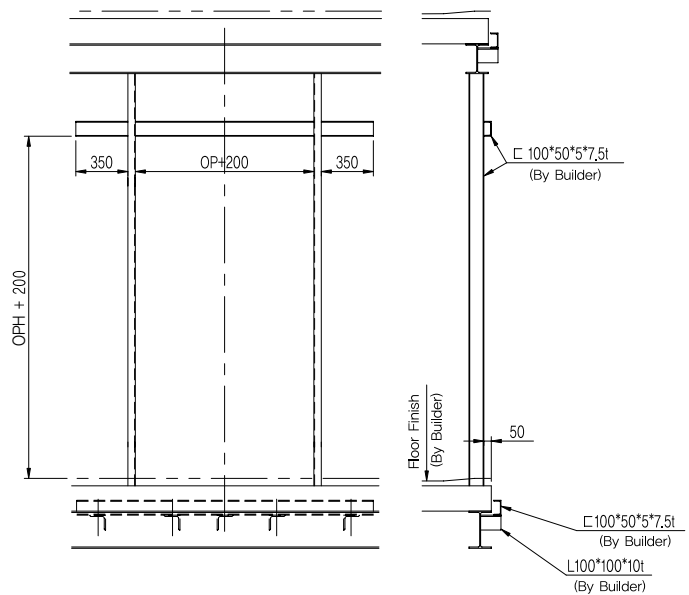

Steel Frame Diagram of Entrance

Technical Data

I Standard

(Unit:mm)

Speed (m/sec)	Capacity		Entrance Opening (mm)	Opening Type	Car Size		Hoistway Size				OH	Pit	Reaction Load (N)	
	Person	Load(kg)			AN	BN	Simplex		Duplex				U(CAR)	V(CWT)
							AH	BH	AH	BH				
1.0	8	550	CLD	800	1350	1050	1900	1550	4000	1550	3800	1200	64000	52700
	9	600		800	1350	1100	1900	1600	4000	1600			76300	63900
	10	700		800	1350	1250	1900	1750	4000	1750			84100	69700
	11	750		800	1350	1350	1900	1750	4000	1750			86000	70500
	13	900		900	1550	1350	2100	1750	4400	1750			101100	82600
	15	1000		900	1600	1450	2150	1800	4500	1800			109100	88500
	17	1150		1000	1800	1450	2350	1800	4900	1800			113700	90000
	20	1350		1000	1800	1650	2550	2000	5300	2000			142800	115000
	24	1600		1100	2000	1700	2750	2050	5700	2050			155300	122400
	27	1800		1100	2200	1700	2950	2050	6100	2050			164200	127200
1.5	8	550	CLD	800	1350	1050	1900	1550	4000	1550	3900 /4150	1300	64000	52700
	9	600		800	1350	1100	1900	1600	4000	1600			76300	63900
	10	700		800	1350	1250	1900	1750	4000	1750			84100	69700
	11	750		800	1350	1350	1900	1750	4000	1750			86000	70500
	13	900		900	1550	1350	2100	1750	4400	1750			101100	82600
	15	1000		900	1600	1450	2150	1800	4500	1800			109100	88500
	17	1150		1000	1800	1450	2350	1800	4900	1800			113700	90000
	20	1350		1000	1800	1650	2550	2000	5300	2000			142800	115000
	24	1600		1100	2000	1700	2750	2050	5700	2050			155300	122400
	27	1800		1100	2200	1700	2950	2050	6100	2050			164200	127200
1.75	8	550	CLD	800	1350	1050	1900	1550	4000	1550	4000 /4200	1350	64000	52700
	9	600		800	1350	1100	1900	1600	4000	1600			76300	63900
	10	700		800	1350	1250	1900	1750	4000	1750			84100	69700
	11	750		800	1350	1350	1900	1750	4000	1750			86000	70500
	13	900		900	1550	1350	2100	1750	4400	1750			101100	82600
	15	1000		900	1600	1450	2150	1800	4500	1800			109100	88500
	17	1150		1000	1800	1450	2350	1800	4900	1800			113700	90000
	20	1350		1000	1800	1650	2550	2000	5300	2000			142800	115000
	24	1600		1100	2000	1700	2750	2050	5700	2050			155300	122400
	27	1800		1100	2200	1700	2950	2050	6100	2050			164200	127200
30	2000	1100	2200	1850	2950	2300	6100	2300	170500	129400				

(Unit:mm)

Speed (m/sec)	Capacity		Entrance Opening (mm)	Opening Type	Car Size		Hoistway Size				OH	Pit	Reaction Load (N)	
	Person	Load(kg)			AN	BN	Simplex		Duplex				U(CAR)	V(CWT)
							AH	BH	AH	BH				
1.0	8	550	TLD	800	1100	1250	1650	1700	3500	1700	3800	1200	64000	52700
	9	600		800	1100	1350	1650	1800	3500	1800			76300	63900
	10	700		800	1100	1500	1650	1950	3500	1950			84100	69700
	11	750		900	1200	1450	1750	1900	3700	1900			86000	70500
	13	900		900	1200	1700	1750	2150	3700	2150			101100	82600
	15	1000		900	1250	1800	1800	2250	3800	2250			109100	88500
	17	1150		1000	1300	1950	1850	2400	3900	2400			113700	90000
	20	1350		1000	1300	2200	2050	2650	4300	2650			142800	115000
	24	1600		1100	1450	2300	2200	2750	4600	2750			155300	122400
	27	1800		1100	1600	2300	2350	2750	4900	2750			164200	127200
1.5	8	550	TLD	800	1100	1250	1650	1700	3500	1700	3900 /4150	1300	64000	52700
	9	600		800	1100	1350	1650	1800	3500	1800			76300	63900
	10	700		800	1100	1500	1650	1950	3500	1950			84100	69700
	11	750		900	1200	1450	1750	1900	3700	1900			86000	70500
	13	900		900	1200	1700	1750	2150	3700	2150			101100	82600
	15	1000		900	1250	1800	1800	2250	3800	2250			109100	88500
	17	1150		1000	1300	1950	1850	2400	3900	2400			113700	90000
	20	1350		1000	1300	2200	2050	2650	4300	2650			142800	115000
	24	1600		1100	1450	2300	2200	2750	4600	2750			155300	122400
	27	1800		1100	1600	2300	2350	2750	4900	2750			164200	127200
1.75	8	550	TLD	800	1100	1250	1650	1700	3500	1700	4000 /4200	1350	64000	52700
	9	600		800	1100	1350	1650	1800	3500	1800			76300	63900
	10	700		800	1100	1500	1650	1950	3500	1950			84100	69700
	11	750		900	1200	1450	1750	1900	3700	1900			86000	70500
	13	900		900	1200	1700	1750	2150	3700	2150			101100	82600
	15	1000		900	1250	1800	1800	2250	3800	2250			109100	88500
	17	1150		1000	1300	1950	1850	2400	3900	2400			113700	90000
	20	1350		1000	1300	2200	2050	2650	4300	2650			142800	115000
	24	1600		1100	1450	2300	2200	2750	4600	2750			155300	122400
	27	1800		1100	1600	2300	2350	2750	4900	2750			164200	127200
30	2000	1100	1700	2350	2450	2800	5100	2800	170500	129400				

Note CH=2428 is standard.

OHmin, Pit depthmin : If A/B, A is for rise < 45 m and B for rise >= 45 m.

Technical Data

EN Code

(Unit: mm)

Speed (m/sec)	Capacity		Entrance Opening (mm)	Opening Type	Car Size		Hoistway Size				OH	Pit	Reaction Load (N)	
	Person	Load(kg)			AN	BN	Simplex		Duplex				U(CAR)	V(CWT)
							AH	BH	AH	BH				
1.0	7	525	CLD	800	1300	1050	1950	1600	4100	1600	3800	1200	64000	52700
	8	630			1350	1100	1950	1650	4100	1650			76300	63900
	9	700			1350	1250	1950	1800	4100	1800			84100	69700
	10	800			1350	1350	1950	1800	4100	1800			86000	70500
	12	900			1550	1350	2150	1800	4500	1800			101100	82600
	13	1000			1600	1450	2200	1850	4600	1850			109100	88500
	15	1150			1800	1450	2400	1850	5000	1850			113700	90000
	18	1350			1800	1650	2600	2050	5400	2050			142800	115000
	21	1600			2000	1700	2800	2100	5800	2100			155300	122400
	24	1800			2200	1700	3000	2100	6200	2100			164200	127200
	26	2000			2200	1850	3000	2350	6200	2350			170500	129400
	1.5	7			525	CLD	800	1300	1050	1950			1600	4100
8		630	1350	1100	1950			1650	4100	1650	76300	63900		
9		700	1350	1250	1950			1800	4100	1800	84100	69700		
10		800	1350	1350	1950			1800	4100	1800	86000	70500		
12		900	1550	1350	2150			1800	4500	1800	101100	82600		
13		1000	1600	1450	2200			1850	4600	1850	109100	88500		
15		1150	1800	1450	2400			1850	5000	1850	113700	90000		
18		1350	1800	1650	2600			2050	5400	2050	142800	115000		
21		1600	2000	1700	2800			2100	5800	2100	155300	122400		
24		1800	2200	1700	3000			2100	6200	2100	164200	127200		
26		2000	2200	1850	3000			2350	6200	2350	170500	129400		
1.75		7	525	CLD	800			1300	1050	1950	1600	4100	1600	4000 /4200
	8	630	1350			1100	1950	1650	4100	1650	76300	63900		
	9	700	1350			1250	1950	1800	4100	1800	84100	69700		
	10	800	1350			1350	1950	1800	4100	1800	86000	70500		
	12	900	1550			1350	2150	1800	4500	1800	101100	82600		
	13	1000	1600			1450	2200	1850	4600	1850	109100	88500		
	15	1150	1800			1450	2400	1850	5000	1850	113700	90000		
	18	1350	1800			1650	2600	2050	5400	2050	142800	115000		
	21	1600	2000			1700	2800	2100	5800	2100	155300	122400		
	24	1800	2200			1700	3000	2100	6200	2100	164200	127200		
	26	2000	2200			1850	3000	2350	6200	2350	170500	129400		

(Unit: mm)

Speed (m/sec)	Capacity		Entrance Opening (mm)	Opening Type	Car Size		Hoistway Size				OH	Pit	Reaction Load (N)	
	Person	Load(kg)			AN	BN	Simplex		Duplex				U(CAR)	V(CWT)
							AH	BH	AH	BH				
1.0	7	525	TLD	800	1100	1250	1950	1600	4100	1600	3800	1200	64000	52700
	8	630			1100	1350	1950	1650	4100	1650			76300	63900
	9	700			1100	1500	1950	1800	4100	1800			84100	69700
	10	800			1200	1450	1950	1800	4100	1800			86000	70500
	12	900			1200	1700	2150	1800	4500	1800			101100	82600
	13	1000			1250	1800	2200	1850	4600	1850			109100	88500
	15	1150			1300	1950	2400	1850	5000	1850			113700	90000
	18	1350			1300	2200	2600	2050	5400	2050			142800	115000
	21	1600			1450	2300	2800	2100	5800	2100			155300	122400
	24	1800			1600	2300	3000	2100	6200	2100			164200	127200
	26	2000			1700	2350	3000	2350	6200	2350			170500	129400
	1.5	8			550	TLD	800	1100	1250	1950			1600	4100
9		600	1100	1350	1950			1650	4100	1650	76300	63900		
10		700	1100	1500	1950			1800	4100	1800	84100	69700		
11		750	1200	1450	1950			1800	4100	1800	86000	70500		
13		900	1200	1700	2150			1800	4500	1800	101100	82600		
15		1000	1250	1800	2200			1850	4600	1850	109100	88500		
17		1150	1300	1950	2400			1850	5000	1850	113700	90000		
20		1350	1300	2200	2600			2050	5400	2050	142800	115000		
24		1600	1450	2300	2800			2100	5800	2100	155300	122400		
27		1800	1600	2300	3000			2100	6200	2100	164200	127200		
30		2000	1700	2350	3000			2350	6200	2350	170500	129400		
1.75		8	550	TLD	800			1100	1250	1950	1600	4100	1600	4000 /4200
	9	600	1100			1350	1950	1650	4100	1650	76300	63900		
	10	700	1100			1500	1950	1800	4100	1800	84100	69700		
	11	750	1200			1450	1950	1800	4100	1800	86000	70500		
	13	900	1200			1700	2150	1800	4500	1800	101100	82600		
	15	1000	1250			1800	2200	1850	4600	1850	109100	88500		
	17	1150	1300			1950	2400	1850	5000	1850	113700	90000		
	20	1350	1300			2200	2600	2050	5400	2050	142800	115000		
	24	1600	1450			2300	2800	2100	5800	2100	155300	122400		
	27	1800	1600			2300	3000	2100	6200	2100	164200	127200		
	30	2000	1700			2350	3000	2350	6200	2350	170500	129400		

Note CH=2428 is standard.

OHmin, Pit depthmin : If A/B, A is for rise < 45 m and B for rise >= 45 m.

Technical Data

I Power Supply Plan

(380V)

Speed (m/sec)	Capacity		Motor Capacity (kW)	MCCB Capacity of Building (A)		Power Supply Capacity (kVA)		Lead-in Wire Size (mm ²)		Earth Wire Size (mm ²)		Heat Output (kcal/H)	Starting Power (kVA/set)
	Person	Load(kg)		Simplex	Duplex	Simplex	Duplex	Simplex	Duplex	Simplex	Duplex		
1.0	8	550	4.3	25	30	4.0	5.7	6	6	6	6	825	7.4
	9	600	4.3	25	30	4.4	7.9	6	6	6	6	900	8.5
	10	700	6.3	25	30	4.7	8.6	6	6	6	6	1050	8.7
	11	750	6.3	25	30	5.1	9.2	6	6	6	6	1125	9.2
	13	900	6.3	25	40	5.9	10.7	6	6	6	6	1350	10.9
	15	1000	6.3	40	50	6.5	11.9	6	10	6	6	1500	12.0
	17	1150	7.7	40	50	7.4	13.4	6	10	6	6	1725	13.0
	20	1350	10.4	40	50	8.3	15.2	10	16	6	6	2025	18.2
	24	1600	10.4	40	60	9.9	18.0	10	16	6	6	2400	18.7
	27	1800	10.4	40	75	12.6	23.0	10	16	6	6	2700	20.9
	30	2000	12.7	50	100	14.0	25.6	10	16	6	10	3000	23.0
1.5	8	550	7.3	25	40	6.0	10.9	6	6	6	6	1238	12.5
	9	600	7.3	25	40	6.5	11.9	10	10	6	6	1350	13.5
	10	700	10.1	40	50	6.7	12.2	10	10	6	6	1575	14.5
	11	750	10.1	40	50	7.2	13.1	10	10	6	6	1688	15.4
	13	900	10.1	40	50	8.3	15.2	16	16	6	6	2025	18.4
	15	1000	10.1	40	60	9.3	16.9	16	16	6	6	2250	20.3
	17	1150	13.5	40	75	10.8	19.6	16	16	6	6	2588	22.0
	20	1350	18.7	40	75	12.2	22.1	16	16	6	10	3038	27.9
	24	1600	18.7	50	100	14.4	26.2	16	16	6	10	3600	32.6
	27	1800	18.7	50	125	19.0	34.5	16	16	6	10	4050	36.4
	30	2000	20.3	60	125	21.1	38.3	16	16	6	10	4500	40.1
1.75	8	550	7.3	25	40	7.0	12.7	10	10	6	6	1444	14.9
	9	600	7.3	25	50	7.6	13.9	16	16	6	6	1575	16.1
	10	700	10.1	40	50	7.8	14.2	16	16	6	6	1838	17.3
	11	750	10.1	40	50	8.4	15.3	16	16	6	6	1969	18.4
	13	900	10.1	40	60	9.7	17.7	16	16	6	6	2363	22.0
	15	1000	10.1	40	75	10.8	19.7	16	16	6	6	2625	24.2
	17	1150	13.5	40	75	12.6	22.9	16	16	6	10	3019	26.3
	20	1350	18.7	50	100	14.2	25.8	16	16	6	10	3544	33.3
	24	1600	18.7	60	100	16.8	30.6	16	16	6	10	4200	37.8
	27	1800	18.7	60	125	18.9	34.4	16	16	6	10	4725	42.1
	30	2000	20.3	60	125	21.6	39.3	16	16	6	10	5250	46.5

Technical Data

Technical Features

I Operation Functions

● Standard ○ Option

Feature	Description	
Attendant Operation	The operating mode of an elevator can be changed from the normal automatic operation to the attendant service by an attendant switch.	●
Independent Operation	Key switch in the car operating panel will cancel any existing car calls and hold the door open at the landing position. During independent operation, the car will respond only to car calls.	●
Back-up operation	When the electrical transmission device between the hall call and control panel begins to operate in an abnormal condition and it lasts for some time, the elevator control device is converted to back-up operation automatically. Then, the elevator moves in sequence up and down repeatedly from top to bottom floor to service every other floor which is in normal condition.	●
Safe Drive Operation	When a car stops between floors due to mechanical malfunction, it will descend to the nearest floor at a low speed and hold the doors open after checking all safety measures.	●
Car Call Cancellation	Allows cancellation of an incorrectly registered car call. For example, if you press the button for the wrong floor, you can cancel by pressing the same floor button again.	●
Automatic Turn-Off of Car Light & Fan	Car illumination and fan are turned off automatically in case there is no hall call or car call; this saves energy.	●
Automatic Bypass	A fully-loaded car (more than 80% of rated load) bypasses hall calls in order to maintain maximum operational efficiency.	●
Overload Holding Stop (110% of rated load)	When the number of passengers exceeds the normal capacity, a buzzer sounds and the elevator remains stopped at that floor. When the excessive number of passengers disembark, the buzzer stops, the elevator doors close, and operation continues.	●
Detection of Jammed Hall Button	If a hall button is jammed mechanically, the hall call will be automatically bypassed after being served once, until the program is resolved.	●
Car Door Safety Edge	Extending the full height of the car door, this device causes the doors to return to the fully open position should the door encounter a person or obstacle while closing.	●
Micro Leveling	An automatic two way leveling device is provided to maintain the elevator car level with the landing, regardless of elevator load or direction of travel.	●
N-Plex Operation	It can control up to 4 sets of elevators to optimize allocation of hall calls.	○
Non-Stop Operation	Specific floors which are memorized in control panel can be set to disable using switch on car operating panel or in security room.	○
Parking Operation	The elevator can be automatically parked at the predetermined floor with its doors closed, and the lights and ventilation will be turned off as well.	○
VIP Operation	The specified elevator is controlled by the special call buttons provided only for VIP elevator.	○
Emergency Power Operation	If normal building power supply fails and the building provides emergency power to the controller(s), one elevator at a time will proceed to the lowest landing where it will stop with doors open and with all of its power and operating circuits in an inoperative standby condition.	○
Fire Return Operation	In case of fire, a fireman can use the elevator which is stopped at the specified floor in order to support firemen for fire-fighting.	○
Firemen Operation	In case of fire, a firemen can use the elevator which is stopped at the specified floor in order to support firemen for fire-fighting.	○
Anti-nuisance Operation	In case of substantial difference between the number of calls registered on the car operating panel and actual load in the elevator, the elevator prevents unnecessary operation by cancelling all registered calls when it arrives at the nearest floor.	○
Door Nudging	When the doors remain open for more than the fixed door open time, this feature closes the doors at a reduced closing speed with the buzzer sounding.	○
Voice Synthesizer	This system provides riding passengers with audio information about car operation such as direction of travel, landing floor, etc.	○
Door Photo Sensor	The doors reverse to fully open position if the light ray unit detects an obstacle when the doors are closing.	○

Technical Data

The works below are not included in the elevator installation work and should be carried out by building contractors in accordance with our drawings, relevant international or local codes and regulations.

I Work by Others

Hoistway

- A properly framed and enclosed hoistway, including any ventilation as required by the governing code authority.
- A dry pit constructed to the elevator manufacturer's specifications to reinforce or sustain any vertical on the guide rails and impacted loads from the car and counterweight buffers.
- A metal sill angle or concrete haunch across the full width of the hoistway at each elevator landing.
- Provision of steel bars to fix jamb around the entrance of each floor.
- All cutting, including cutouts to accommodate hall single fixtures, patching, painting of walls, floors, partitions, together with finish painting of entrance doors and frames, if required.
- Provision of entrance or ladder for pit access.
- Supply and installation of fascia plate.
- Installation of emergency exits and electric wiring in blind sections of hoistway where required.
- The tolerance of perpendicular line over the whole hoistway height must not exceed $\pm 30\text{mm}$.
- A waterproof outlet and light fixture in the elevator pit area with the light switch being located adjacent the access door or ladder.
- Suitable light fixture and convenience outlet in the pit with a light switch adjacent to the access door ladder.
- The receptacles shall have protection for ground fault circuit interrupter.
- Provision of wiring between controller and building management system.
- A construction hoisting beam or hook, if required, with the correct location and size as determined by the elevator contractor for each hoistway.
- Noise insulation should be installed between machine room and adjacent residential area.

Miscellaneous

- Wiring and piping between monitoring system.
- Hoistway shall be free of dust or harmful gas.
- All electric power for lighting, tools, welding, etc during installation.
- All single phase receptacles installed in pit, and machinery spaces shall have ground fault circuit interrupter protection.
- Fire detector for fire emergency operation.
- A secured area for storage of elevator equipment and materials during installation.

The Next Generation of Elevator

MUSE™ NV

Machine Roomless Elevator

